

# **X** *MADJAX* **SERIES** STORM

**3**  
**YEAR**  
.....  
*LIMITED*  
**WARRANTY**







*For 55+ years, we have been living and breathing golf carts.*

We have a long heritage of pride in creating the best aftermarket golf cart parts and accessories, allowing you to personalize your golf cart, customize it for your needs, and upgrade it to meet your standards for comfort and luxury.



The next evolution was for us to provide a full golf cart solution – to take all of those upgraded parts and accessories that put us on the map, and provide them in one golf cart from the get go.



INTRODUCING THE

# **MADJAX** **X** **SERIES**

*Best-in-class innovation and design,  
grounded in history.*

The MadJax XSeries provides the most comfortable ride on the market. Your family will love piling in and riding to get ice cream, visit friends, and create those special memories that life is all about.

With an industry-leading 3-year warranty and in-stock replacement parts and accessories, the MadJax XSeries provides you with ease and peace of mind for the long run.



# GET IT ALL WITH THE MADJAX XSERIES

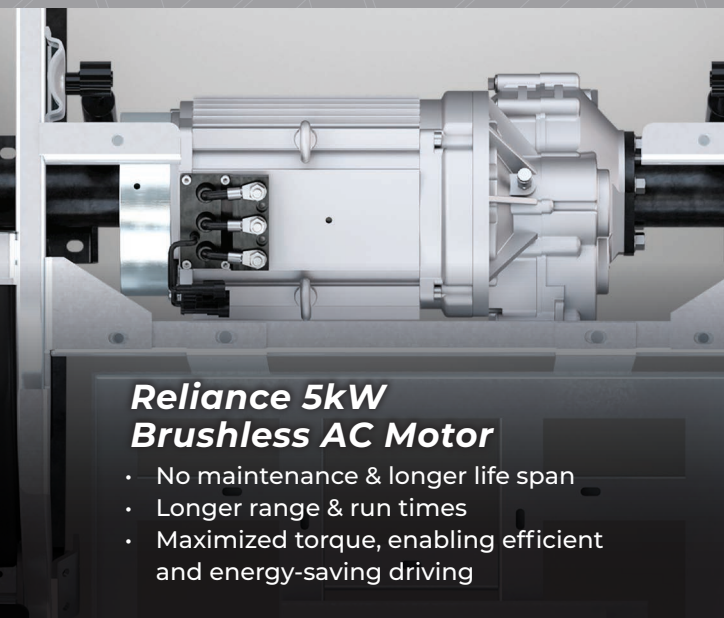

## Reliance 5kW Brushless AC Motor

- No maintenance & longer life span
- Longer range & run times
- Maximized torque, enabling efficient and energy-saving driving



## 400A Reliance Control System

- Powerful 400amp control system provides high output
- Fast acceleration
- Ultimate driving power



## Independent Front Suspension & Rear Springs with Hydraulic Shocks

- Provides a high-end, luxury ride quality
- Dampened vibration for a smoother ride
- Easier vehicle maneuverability

## RELIANCE 5KW BRUSHLESS AC MOTOR



## HIGH CAPACITY VOLTAGE REDUCER

## 400A RELIANCE CONTROL SYSTEM

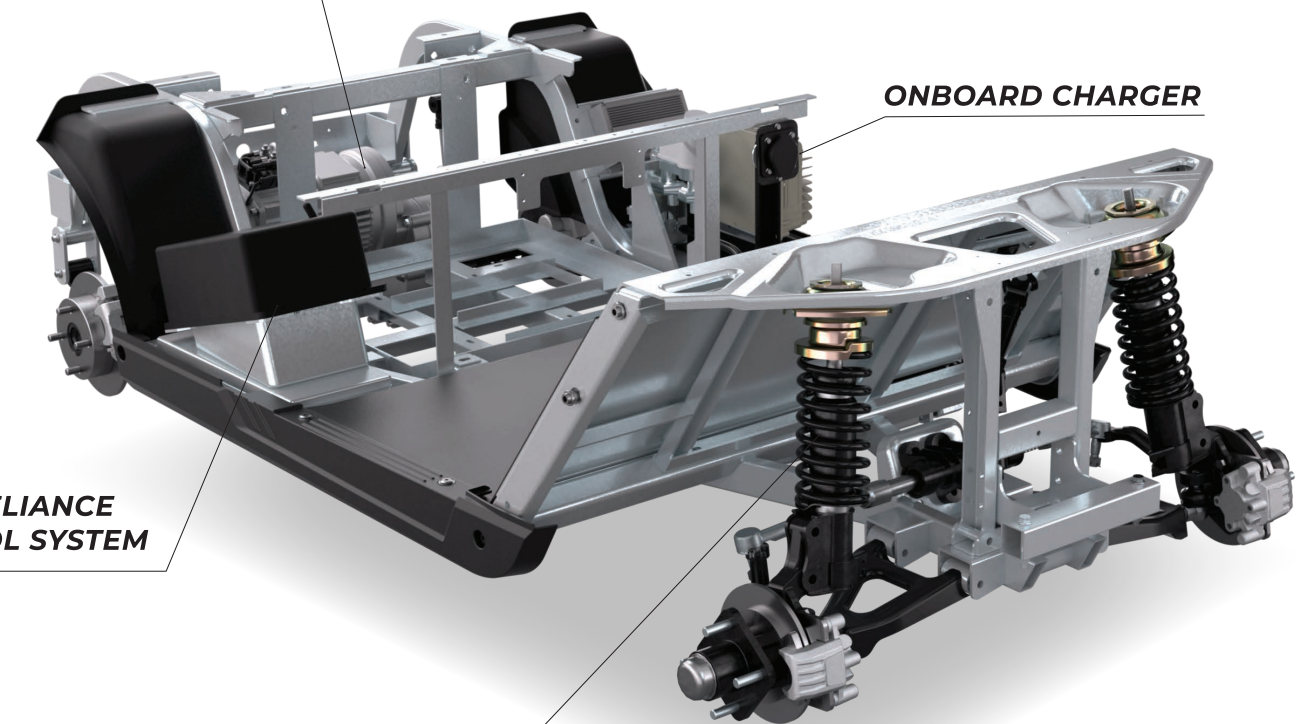

## ONBOARD CHARGER

## INDEPENDENT FRONT SUSPENSION & REAR SPRINGS WITH HYDRAULIC SHOCKS

## 4-WHEEL HYDRAULIC DISC BRAKING SYSTEM

## High Capacity Voltage Reducer

- Allows you to power multiple additional accessories, including USB ports, extra lights, speakers & more



## Onboard Charger

- Allows you to charge by plugging the golf cart in directly, vs. needing a separate bulky charger
- Energy-efficient, high output

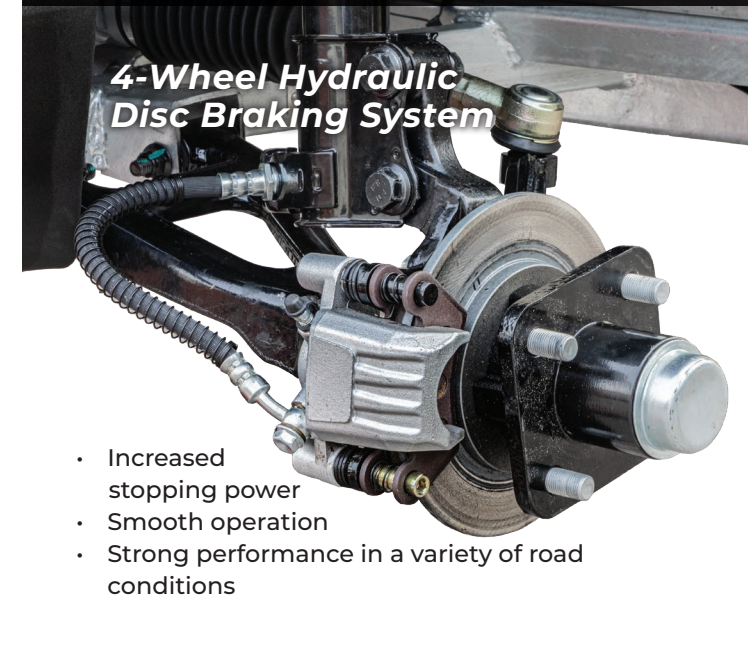

## 4-Wheel Hydraulic Disc Braking System

- Increased stopping power
- Smooth operation
- Strong performance in a variety of road conditions



INTRODUCING THE FIRST  
OF THE **MADJAX XSERIES** LINEUP,



**Enhanced Visibility**

Comes with side mirrors and overhead convex mirror to increase visibility of your surroundings.

**Light Up the Road**

Premium, flush-mounted, front & rear LED lights with sleek, black housing and clear lens cover. Headlights are equipped with high & low beams and accent running lights.

**Exclusive Storm Design**

Unique front cowl & rocker panels with a large fascia and grille. Stylish details and an automotive-style body, available in 6 colors

**Strong, Rust-Free Frame**

Hot dipped, galvanized steel frame provides superior corrosion coating options.

**Comfortable and Controlled Steering**

Responsive handling and excellent turning radius giving you full control

**Available Premium Seating Offerings**

Offer superior comfort

**Durable Floor Mats**

Offering style and protection, floor mats come standard in our signature MadJax X-pattern.

**Sturdy Exterior Parts**

Durable fender flares and optional textured, drop down nerf bars





## Wheels & Tires

LARGE SELECTION

MADJAX



Offering a wide variety of wheels and tires to fit your lifestyle.



**Bravo**  
14", 15"



**Evolution**  
15"



**Omega**  
12", 14"



**Raven**  
14", 15"



**Spyder**  
12", 14", 15"



**Specter**  
12", 14"



**Tempest**  
12", 14"



**Vortex**  
12", 14"



Tire Options - Check out our guide below to find out what tire type fits your ride the best.

Street

All-Terrain



VEHICLE USAGE



Paved roads & sidewalks



Mix of paved & off-road

## Clear, Bright LEDs ENHANCED VISIBILITY



Customize Your Colors with RGB3 Technology

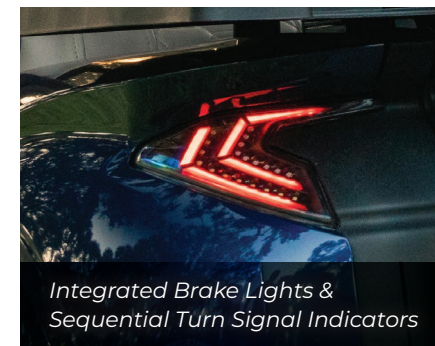

Integrated Brake Lights & Sequential Turn Signal Indicators

Our unique LUX Lights come standard\* and include:

- Daytime Running Lights
- Self-cancelling, sequential turn signals
- Integrated Reverse Lights
- Clear, Crisp Horn

\*2024 model year only

## Plush, Bolstered Seats

MADE WITH PREMIUM MATERIALS FOR SUPERIOR COMFORT



Unique, Inlaid Honeycomb Pattern

Modern Styling & Extra Soft Foam

MadJax® Colorado Series Seats



Graphite



Beige

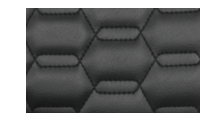

Black



White



RedDot.

Double Diamond Stitching Pattern

Added Bolstering for Extra Comfort

RedDot® Suede Premium Seats



Honey

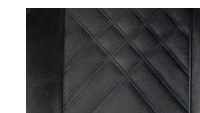

Black



Pewter



RedDot.

Pleated Vinyl Panels with Piping Accent

Automotive-Inspired Stitching

RedDot® Vinyl Premium Seats

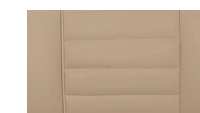

Light Beige

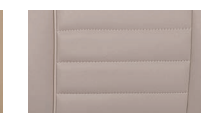

Mushroom



Gray

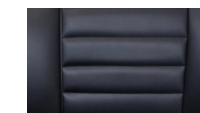

Black



White



# FEATURES & AVAILABLE SELECTIONS



## Vibrant Colors

OUR STORM BODY IS OFFERED IN 6 RICH, HIGH-QUALITY COLORS

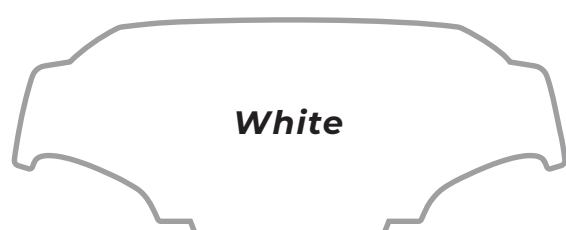
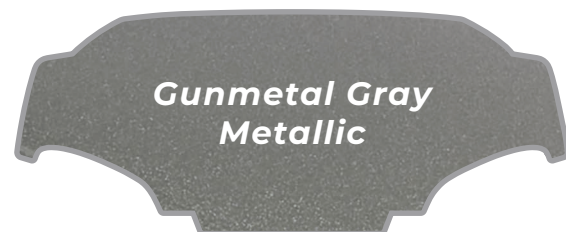

## Premium Steering Wheel

ERGONOMIC GRIP,  
PREMIUM COMPONENTS



Stylish & Comfortable Design

## Battery RELIANCE.



48V  
Lead Acid

OR



48V  
Lithium

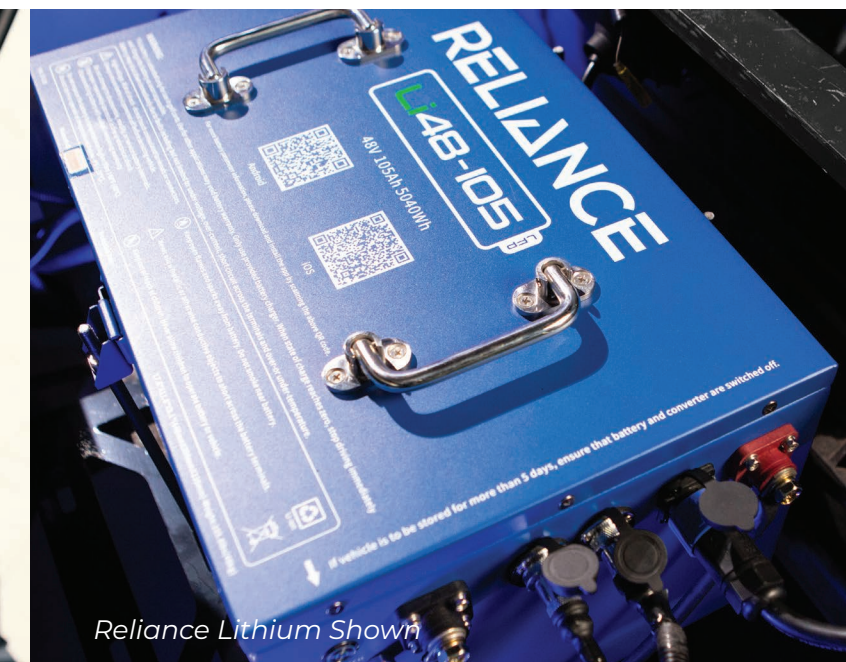

Reliance Lithium Shown

## Windshields RedDot.

HIGH-GRADE FADE &  
SHATTER-RESISTANT ACRYLIC



1/4" Folding - Tinted



1/4" Folding - Clear







**OUTSTANDING  
CUSTOMER SUPPORT**

*US-based customer service team with extensive product knowledge. Our team provides a level of customer support like no other.*



**INDUSTRY BEST  
WARRANTY COVERAGE**

*Our 3-year limited warranty provides peace of mind and no headaches down the road.*



**PARTS & ACCESSORIES  
MADE SIMPLE**

*Fully stocked service, replacement parts, and accessories are available right at your dealer.*





# VEHICLE SPECS

## DIMENSIONS

OVERALL LENGTH	92.7 in (235.5 cm)
OVERALL WIDTH	45.5 in (115.5 cm)
WHEEL BASE	65.7 in (167 cm)
FRONT WHEEL TRACK	37.0 in (94 cm)
REAR WHEEL TRACK	38.8 in (98.5 cm)
GROUND CLEARANCE @ DIFF.	4.72 in (12 cm)

## POWER

POWER	48-Volt Lithium or Lead Acid
MOTOR TYPE	Reliance AC Motor
HORSEPOWER (KW)	6.7 hp (5 kW) Continuous
WIRING	3 Gauge Cables Throughout
DC CONVERTER	30 Amp Reliance Voltage Reducer for 12 Volt Power
BATTERIES (QTY/TYPER)	48v Lithium or 6 x 8v batteries
KEY OR PEDAL START	Pedal
BATTERY CHARGER	Reliance On-Board Charger w/3.0 m AC Cord
SPEED CONTROLLER	400-Amp Reliance Solid-State AC Controller
DRIVETRAIN	Motor Shaft Direct Drive
TRANSAXLE	Open Differential with Helical Gears
GEAR SELECTION	Forward-Neutral-Reverse Rotary Style Switch
REAR AXLE RATIO	12.3:1

## BODY & CHASSIS

FRAME	Welded Steel with Hot Dipped Galvanized Protection
BODY & FINISH	Injection Molded Polypropylene

## COLOR OPTIONS

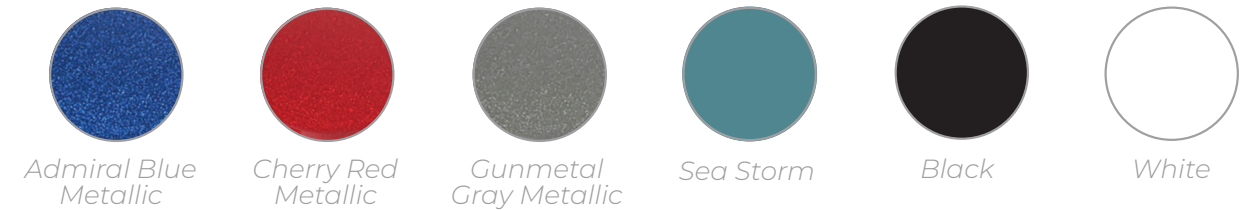

## STEERING & SUSPENSION

STEERING	Double-Ended Rack and Pinion
FRONT SUSPENSION	MacPherson Strut
REAR SUSPENSION	Mono-Leaf Springs with Hydraulic Shocks
SERVICE BRAKE	Front/Rear Hydraulic Disc Brake
PARKING BRAKE	Electromagnetic Park Brake
DRY WEIGHT	573 lb (260 kg)(without battery estimated)
CURB WEIGHT	992 lb (450 kg) estimated for 4 pass
VEHICLE LOAD CAPACITY	800 lb (363 kg)
OUTSIDE CLEARANCE CIRCLE	22.9 ft (7 m)
SPEED (LEVEL GROUND)	19.5 mph

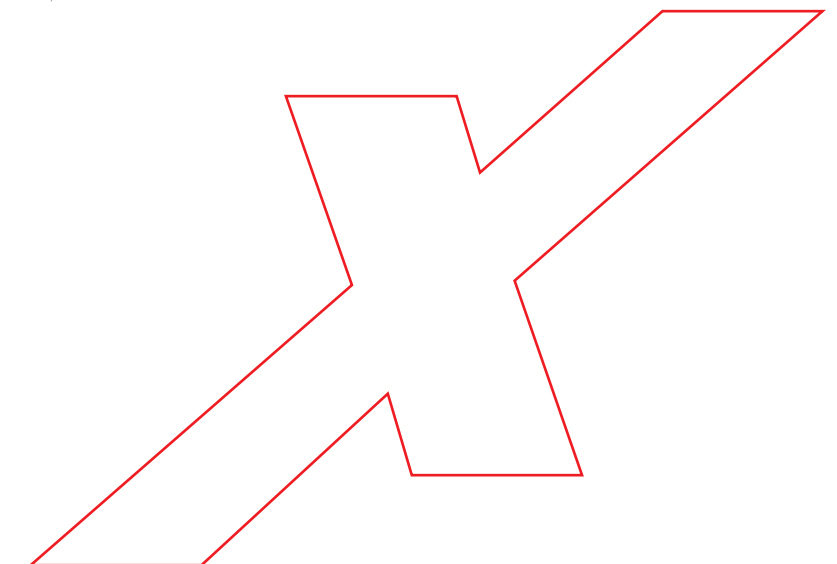





**MADJAX**  
**X SERIES**  
STORM